



WELVET 81006

TOOL BOX 800 mm



External dimensions (mm): 830x500x470

Weight (kg): 10.5

Optimal load (kg): 65

Capacity (lt): 119

Quantity per pallet (n°): 10

Pallets dimensions (cm): 105x85x265

Pallet Weight (kg): 130

TECHNICAL FEATURES

Material: polypropylene

Production Process: Injection Molding

Label with company logo

COMPONENTS

- Nylon handle
- EPDM seal
- Europlex lock (European Patent EP 1442845)

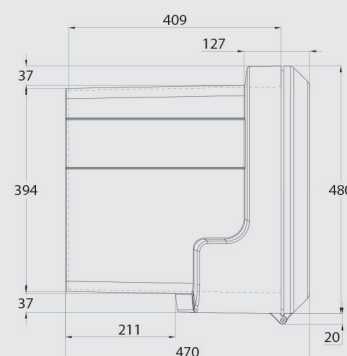

TEST AND CERTIFICATIONS

- **FEM method:** Result of the test load resistance conducted with simulation software

Applied load: 1600 N

Tensione max (stress): 12.89 MPa, (Limite Von Mises 22 MPa)

max deformation: 9.04 mm

Optimal load: 650 N

- **IP TEST** (TÜV Rheinland 7/2012)

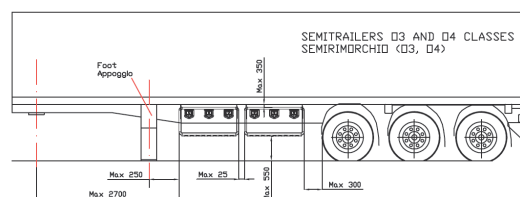

- **TÜV RHEINLAND** or side protection (conformity to EU Directives 89/297 / EEC and ECE Reg. N. 73)

PRODUCT FEATURES

- 1 Europlex lock with cylinder
- 2 Compression locking system with rubber seal
- 3 The continuous contact points between body and lid
- 4 The Reinforced body guarantees maximum load avoiding "U" bracket mounting
- 5 Smooth internal surface
- 6 reinforced lid



OPTIONALS

VERTICAL BRACKETS: 88020, 88120, 88220

HORIZONTAL BRACKETS: 88030, 88130, 88230

SPARE PARTS: 89010, 89501, 89503, 89502

OPTIONS: Resin label, Serigraphed logo, shelves, gas spring, chain